

AQUACULTURE - LICENSING UNDER
FISHERIES (AMENDMENT) ACT, 1997 and
FORESHORE ACT, 1933

SHELLFISH AND FINFISH

Aquaculture and Foreshore Licence Application Form

Important Note

Section 4 of the Fisheries and Foreshore (Amendment) Act, 1998 (No. 54) prohibits any person making an application on or after 10 December 1998 for an Aquaculture Licence from commencing aquaculture operations until duly licensed under the Fisheries (Amendment) Act, 1997 (No. 23), and provides that a breach of that prohibition will cause the application to fail.

**Aquaculture & Foreshore Management Division
Department of Agriculture, Food and the Marine.
National Seafood Centre,
Clonakilty, Co. Cork**

Fax: (023) 8821782

**AQUACULTURE AND FORESHORE LICENSING APPLICATION FORM, for purposes
of FISHERIES (AMENDMENT) ACT, 1997 and FORESHORE ACT, 1933**

*Accompanying Guidance Notes should be read
before completing this form.*

Note: Details provided in Parts 1 and 2 will be made available for public inspection.
Details provided in Part 3 are confidential and are not for public disclosure.

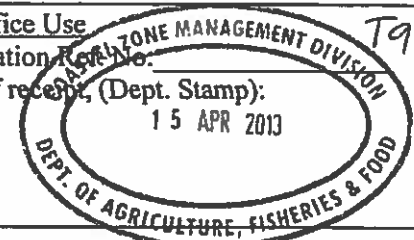
For Office Use Application No. _____ Date of receipt (Dept. Stamp): 15 APR 2013 	T9/377
---	--------

USE BLOCK CAPITALS IN BLACK INK

PART 1: PRELIMINARY DETAILS

Name(s) of Applicant(s) in full:	
I.A Michael John HARTY	
I.B MARIAN HARTY	
Address(es) of Applicant(s) in full:	
I.A Tawn Olanmore Galway	I.B Tawn, Olanmore Galway
RS/PPS No./VAT No*: [REDACTED]	[REDACTED]
Tel: [REDACTED] Fax: [REDACTED]	Tel: [REDACTED] Fax: [REDACTED]

* Limited Companies must include their VAT No.

<u>I.C TYPE OF APPLICATION</u>	Insert X in relevant box
Indicate the relevant type of application:	
-(i) Aquaculture Licence	<input type="checkbox"/>
-(ii) Trial Licence	<input type="checkbox"/>
-(iii) Review of Aquaculture Licence	<input type="checkbox"/>
-(iv) Renewal of Aquaculture Licence	<input checked="" type="checkbox"/>
-(v) Foreshore Licence	<input type="checkbox"/>
(This Application Form is valid for each type of application.)	

<u>I.D TYPE OF AQUACULTURE</u>	
Indicate the relevant type of application:	
-(i) Land-based	<input type="checkbox"/>
-(ii) Marine-based	<input checked="" type="checkbox"/>
-Shellfish	
(iii) - extensive	<input type="checkbox"/>
(iv) - intensive	<input type="checkbox"/>
-(v) Finfish	<input type="checkbox"/>

1. E DOCUMENTS ENCLOSED WITH THIS APPLICATION

The following documents are enclosed with this application:

- (1) - Ordnance Survey Map (Scale of 1: 10,560, ie, a six inch map) **OBLIGATORY**
- (2) - British Admiralty Chart (largest available scale)
- (3) - Decision of planning authority under Planning Acts
- (4) - Copy of licence under Section 4 of Local Government (Water Pollution) Act, 1977
- (5) - Environmental Impact Statement
- (6) - Drawing of the structures to be used and/or the layout of the farm **OBLIGATORY**
- (7) - Water Quality Analysis Report (required for Land-based sites only)
- (8) - Application Fee **OBLIGATORY**
- (9) - Other (specify): _____

PART 2: DETAILS RELATING TO PROPOSED AQUACULTURE PROJECT

2.A Employment, Qualifications, Experience, Etc.

(i) Details of Applicant's qualifications and experience in aquaculture: _____

Farming Oysters for 30 years.

(ii) Other relevant experience (courses attended, etc): _____

(iii) Details of projected employment creation during first four years of proposed development: _____

(iv) Projected employment (number of persons):

Year 1:		Year 2:		Year 3:		Year 4:	
---------	--	---------	--	---------	--	---------	--

2.B Aquaculture Site Details

Indicate type of site:

- (i) Land-based
- (ii) Marine-based

<input type="checkbox"/>
<input checked="" type="checkbox"/>

2.C Land-Based Site

(To be completed if appropriate)

(i) State species to be farmed: Pacific Oyster

(ii) State proposed system of culture e.g., pond, raceway, circular tank or other method:

Steel Truss, Nursery Boxes

(iii) Full address of proposed site including Townland and County:

Tawin

(iv) Tonnage to be produced:

Year 1:	Year 2:	Year 3:	Year 4:
---------	---------	---------	---------

(v) Proposed source of stock:

(vi) Name of river(s) supplying site with water:

(vii) Estimate drought flow in gallons per minute:

(viii) Is there a fall of 1.5 metres in the water level at this site or can this be obtained by damming the river without giving rise to flooding of your own or neighbour's land upstream of the site? _____

(ix) Area of proposed site (hectares): _____

(x) Details of services available on the site e.g., main road access, electricity: _____

(xi) Are there at present any possible sources of pollution upstream of the site, e.g. discharge from sewerage plant, farmyard, sheep dip facility, silage effluent, quarry, sandpit or factory?

YES NO

(xii) If yes, supply details: _____

Land-based Site (continued)

2.D The following must be supplied:

- (i) Sketch of the layout of the site in relation to the river(s), road(s) and buildings;
- (ii) Water quality Analysis Report, which should be drawn up in accordance with the parameters set out in Annex C of the Guidance Notes.

2.E The following conditions must be met in order to allow for consideration of licensing of land-based aquaculture:

- (i) the buildings and equipment must be put in place to the Department's satisfaction; and
- (ii) the operation must comply with Local Authority requirements.

2.F Marine-based Site(s)

(To be completed if appropriate)

Location - (i) Bay: Mweeloon, Tawin

- (ii) County: GALWAY

(iii) OS Map No: PLEASE Find Attached

(iv) Site Co-ordinates PLEASE Find Attached Pages with Co. ODS

(v) Size (hectares): 1.6 1.9

(vi) Species (common and scientific name):

Pacific (Crassostrea gigas

-Aquatic Plant(s)

-Any form of aquatic food suitable for the nutrition of fish

(vi) Method of culture (e.g., nets, ropes, tanks, trestles, etc.) trestles, Nursery boxes

(vii) Drawings of structures to be used in method of culture should be enclosed.

(viii) If cages or tanks are proposed, state:

- (a) Number: 200 Boxes

- (b) Type and shape: Please See Diagram

- (c) Cubic Capacity: Please See Diagram

- (d) Depth: Please see Diagram

(ix) Proposed specific site locations (with reasons):

Proven Rate of Growth Here and Easy Access

(x) Describe proposed purification facilities to be used, where appropriate: N/A

Marine-based Site(s) (continued)

2.G Give details of any special requirements relating to the health of the proposed project and the wider matters of public health and safety: _____

Sites Marked For Marine Navigation

2.H Tonnage to be produced:

<u>Species</u> (To state)	<u>Year 1:</u>	<u>Year 2:</u>	<u>Year 3:</u>	<u>Year 4:</u>
Pacific Oyster	1 tonne	1.5 Tonne	2 Tonne	2.5 Tonne
_____	_____	_____	_____	_____
_____	_____	_____	_____	_____
_____	_____	_____	_____	_____

2.I Reasons for selection of site(s):

Shelter area from worst of Storm + tidal damage
Proven Growth area's for oysters

Note: The proposed access route to the site(s) from public road across tidal foreshore area must be indicated on the OS map accompanying the application.

2.J Environmental Impact Statement (EIS).

A copy of an EIS, if required, should be enclosed with the application. The EIS should contain the information specified in Annex B of the Guidance Notes.

2.K Trial Licence.

(To be completed if appropriate)

Describe experimental or investigative nature of the proposed project: _____

[Use separate page if required - to be signed and dated]

B. MARKETING (continued)

3. Will the product be processed or packaged?

YES NO

4. If yes, give details:

Will be Graded to Certain Sizes
and boxed for @haulage.

I/We hereby declare the information provided in Parts 1, 2 and 3 above to be true to the best of my/our knowledge. I/We enclose an application fee* of € 63.49 cent with this application.

Signature(s) of Applicant(s):

Michael Harty

Marion Harty

Date:

8.4.2013

*Preferred method of payment is by cheque or bank draft. The fee should be made payable to the Department of Agriculture, Food and the Marine.

This form should be forwarded, with the required documents and application fee, to:

Aquaculture Licensing
Aquaculture & Foreshore Management Division
Department of Agriculture, Food and the Marine
National Seafood Centre,
Clonakilty,
Co. Cork

Oyster Nursery Boxes will be Sown by Rope and anchored by Concrete anchor.

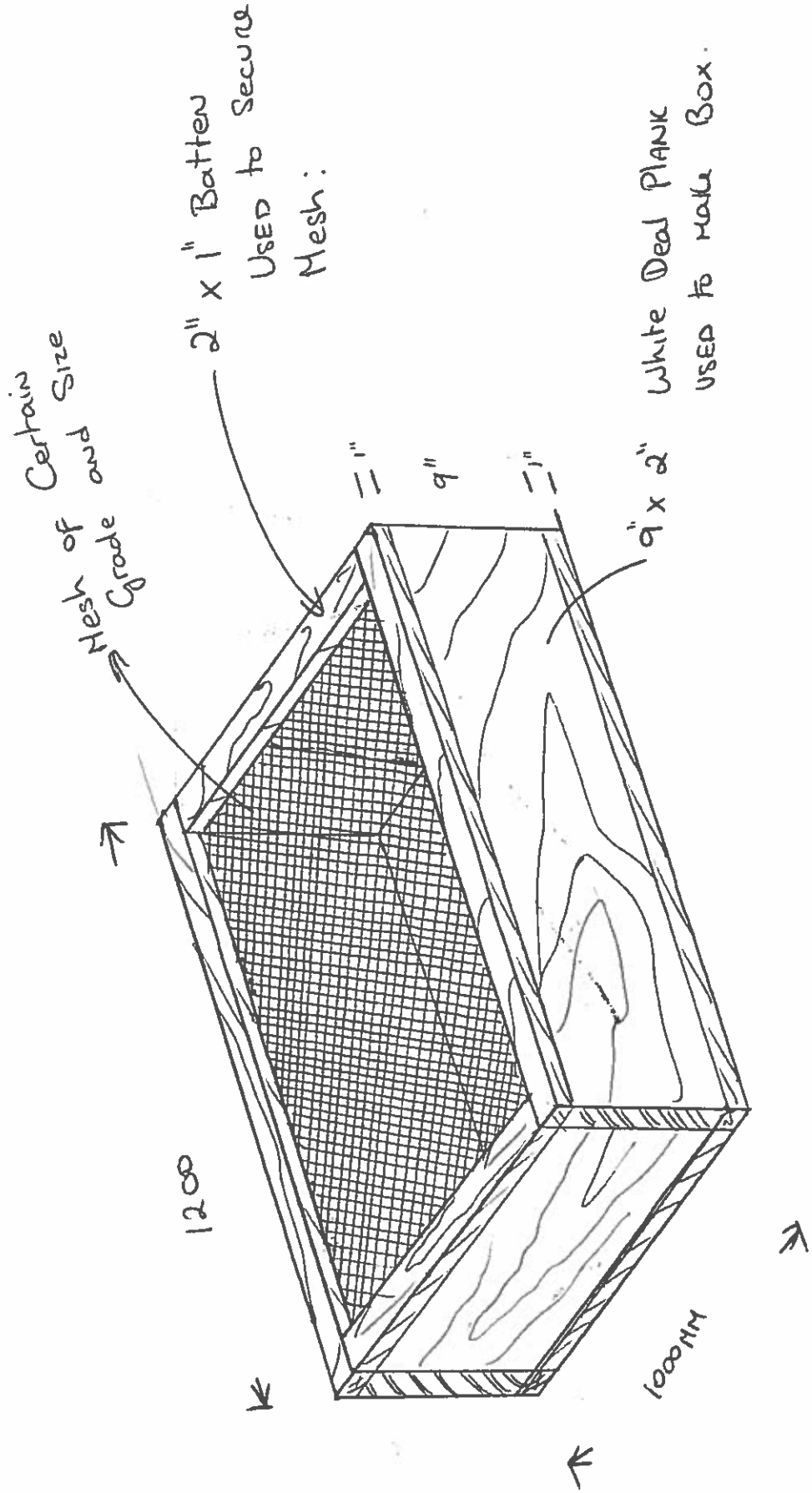



1 NO. SITE IN MWEELON , GALWAY BAY, CO. GALWAY

Co-ordinates & Areas

Site T09/ 377B (1.0 Ha)

The area seaward of the high water mark and enclosed by a line drawn from Irish National Grid Reference point

132600 , 219100 to Irish National Grid Reference point
132700 , 219100 to Irish National Grid Reference point
132700 , 219000 to Irish National Grid Reference point
132600 , 219000 to the first mentioned point.

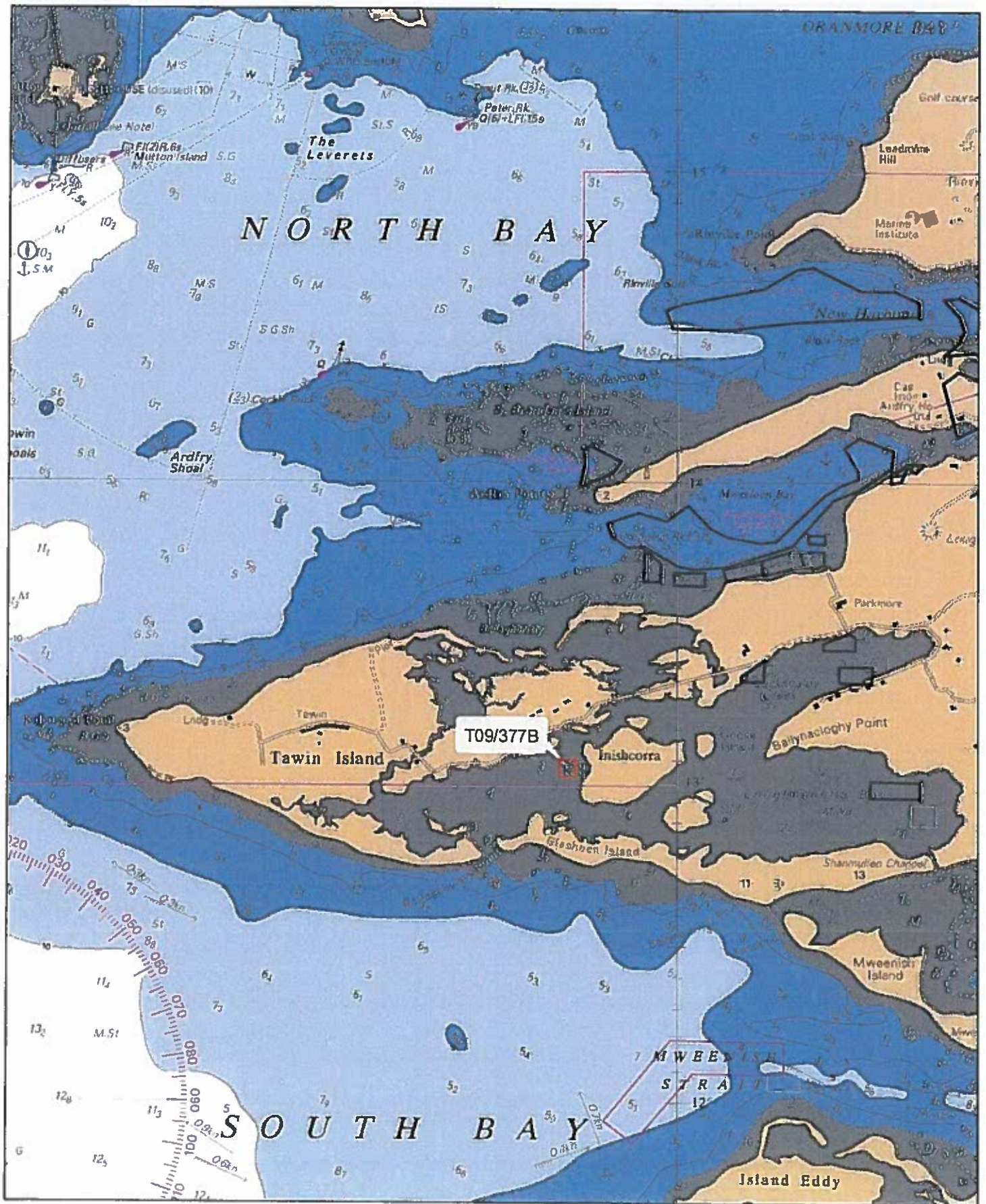

Aqua Culture Sites

(all other values)

Site_Status	Description
	Application
	Lapsed
	Licensed
	Refused
	Renewal
	Revoked
	Surrendered
	Withdrawn

1:30,000

Site Highlighted in red denotes Application

Part of Admiralty Chart No 1984-0
Not to be used for Navigation



Department of
**Agriculture,
Food and the Marine**

An Roinn
**Talmhaíochta,
Bia agus Mara**

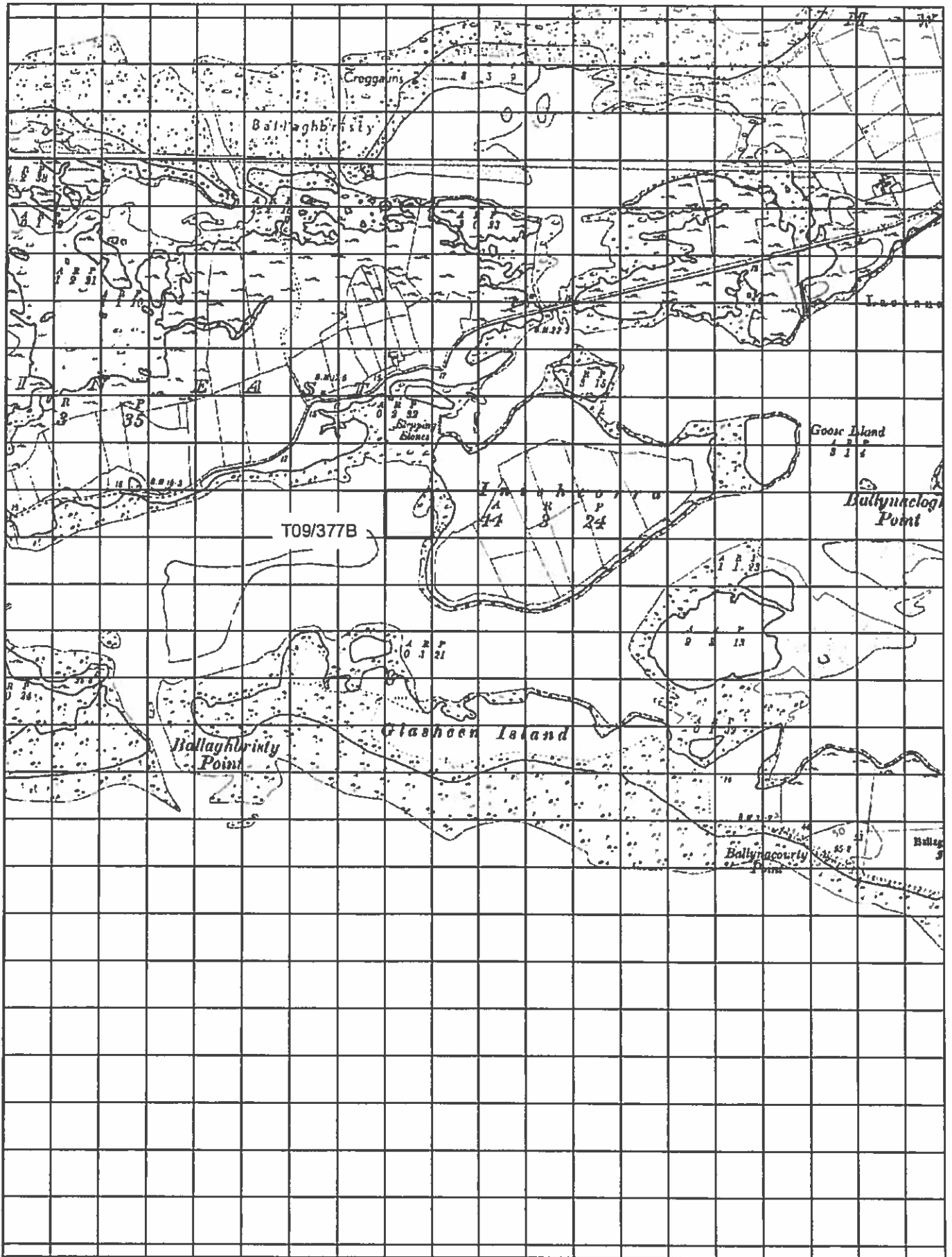







T09/377B

1:10,560

Aqua Culture Sites

<all other values>

Site Status

-  Application
-  Lapsed
-  Licensed
-  Refused
-  Renewed
-  Revoked
-  Surrendered
-  Withdrawn
-  100 Meter Reference Grid

Site Highlighted in red denotes Application

Ordnance Survey Ireland Licence No. EN 0076413
 © Ordnance Survey Ireland/Government of Ireland



Department of
**Agriculture,
 Food and the Marine**
 An Roinn
 Talmhaíochta,
 Bia agus Mara

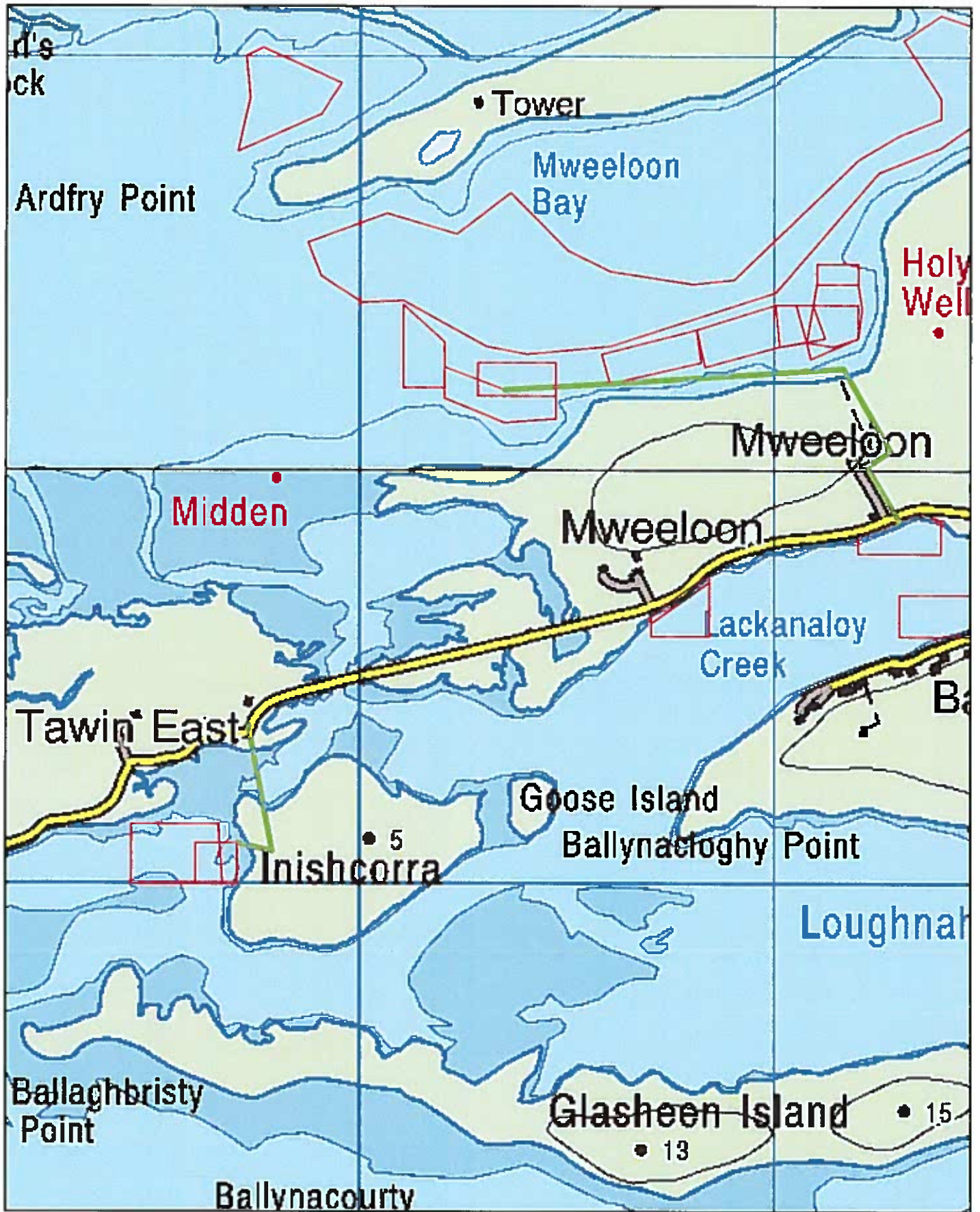

Access to T9/377 (green lines denotes vehicular access)

1:12,500

